

Specification

Product: Touch TFT Display

APT Model: TOUCH

This is a universal display for several types of systems. Some display functions may not be compatible with your system. Ask your dealer for specifics.

Content

1.	Product name and model	3
2.	Suppliers	3
3.	Specifications	3
4.	Dimensions and Material	4
5.	Features	5
6.	Main page	6
7.	Functional Description	7
7.1	Power On/Off	7
7.2	User interface operating	7
7.3	Assistant level	8
7.4	Speed & Mileage mode	8
7.5	Headlight / Display Mode/ Light Sensor	9
7.6	Walking mode (6km)	9
7.7	Data cleanup	10
7.8	USB charging port	10
8.	Menu Page	10
8.1	Basic settings	11
8.1.1.	Language	11
8.1.2.	System	12
8.1.3.	Brightness	12
8.1.4.	Automatic shut down	13
8.1.5.	Temperature	13
8.1.6.	Battery Ind	14
8.1.7.	Power Ind	15
8.1.8.	Clock	15
8.1.9.	Security	16
8.2	Device setting	19
8.2.1.	Wheel	19
8.2.2.	Battery Voltage	20
8.2.3.	USB Port	20
8.2.4.	Light sensor	20
8.2.5.	Offset Voltage	21
8.3	Advanced setting	21
8.3.1.	Speed Limit	22
8.3.2.	Calorie	22
8.3.3.	Maintenance	23
8.3.4.	Gear number setting	23
8.3.5.	Riding mode	24
8.3.6.	Factory Setting	25
8.4	About Device	25
8.4.1	Product Information	25
8.4.2	Battery Information	25
9.	Chart page	26

10.	Errors code	27
11.	Assembly instructions	28
11.1	Regular bracket.....	28
11.2	Headlight bracket.....	28
12.	Install and use precautions	28
13.	Copyright Notice	29

1. Product model

Model: TOUCH

2. Suppliers

China

3. Specifications

- ★3.5inch TFT screen(IPS 320*480 pixel)
- ★Capacitive multi-touch screen
- ★Tempered glass panel, GFF full lamination process
- ★2D graphics acceleration engine, car dashboard UI, refresh rate 60fps
- ★Multi-language support
- ★Pattern unlock, more efficient and safe
- ★Two brackets optional: regular bracket / integrated headlight bracket
- ★USB Type-C interface, DC 5V 500mA
- ★Riding data graph
- Wide-voltage range: 24~65V / 48-90V (optional)
- Light Sensor
- Maximum output current to controller: 200mA、off-leakage current <math><1\mu\text{A}</math>
- Operating temperature : -20~70°C、Storage temperature -30~80°C
- IP65
- EN15194/2017
- RoHS

4. Dimensions and Material

Shell and bracket is made with ABS+ PC, panel is tempered glass.



Front View

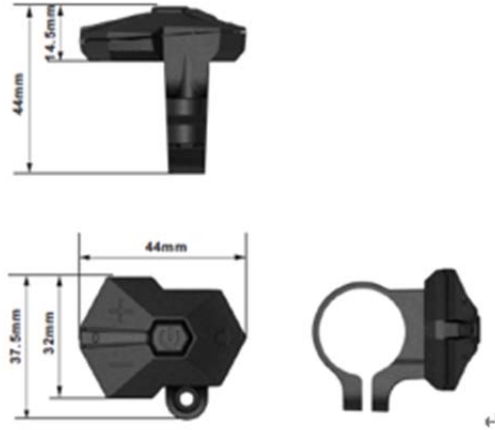

Key

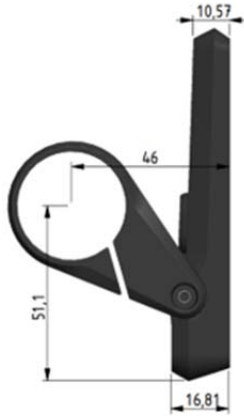

Side View (Regular bracket)

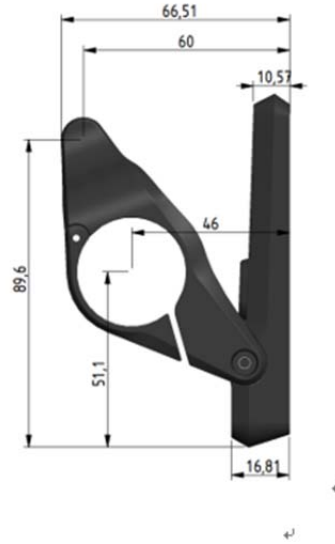

Side View (Headlight bracket)

mm ↵

5. Features

- **★3.5inch TFT screen (IPS 320*480 pixel), Capacitive multi-touch screen**
All items can be set through touch screen conveniently.
- **★8 languages:**
German, French, Korean, Dutch, Italian, English, Chinese, Czech are supported.
- **★Pattern unlock**
If you forget the pattern, you can reset it by security questions.
- **★Two brackets are available:** regular or integrated headlight bracket
- **★USB charging port: Type-C, 5V 500mA**
- **★Tempered glass panel, GFF full lamination process**
High strength and scratch resistance, improve outdoor readability, no mists
- **★Speed and energy diagram for last 60 minutes**
- **★Voltage sampling offset compensation**
Offset Voltage can compensate voltage sampling deviation caused by hardware, range from -1.0V to 1.0V. Voltage value on Main Page will be more accurate($\pm 0.1V$).
- **Light Sensor**
- **Independent button, easy to operate**
- **Speed indicator:** Speed (Real-time), AVG Speed, MAX Speed
- **Metric / Imperial**
- **Smart battery indicator:** Capacity (percentage) or Voltage
- **Mileage indicator:** Odometer, Trip distance, Range (if controller support)
- **Clock indicator:** Built in battery, clock keeps running when power off
- **Brightness setting:** Day and Night Brightness can be set independent
- **Power/ Current indicator:** Real-time Power(W) or Current(A).
- **Errors Code tips**
- **Firmware upgrade:** Upgrade the Logo individually

6. Main page

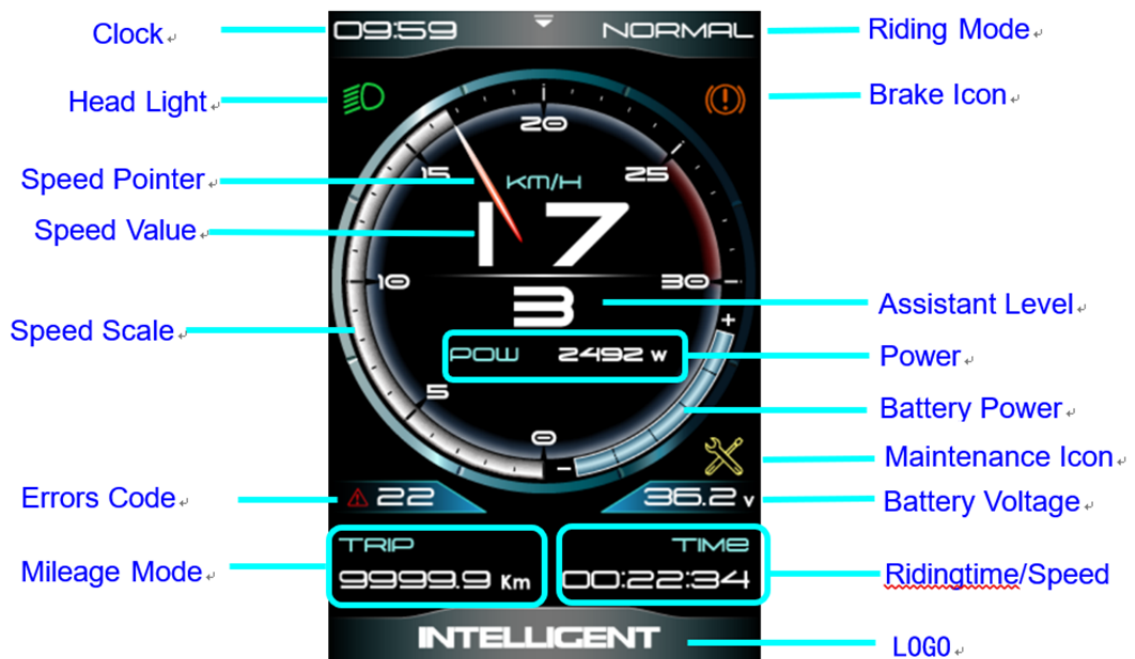

- **Clock:** 24hour clock
- **Head Light:** Head Light on/ off.
- **Speed Value:** Real-time Speed, Km/h or MPH.
- **Errors Code:** Showed when checking errors.
- **Mileage Mode:** Odometer, Trip distance, Range (if controller support)
- **Riding Mode:** NORMOL, SPORT (if controller support)
This function needs controller to support.
- **Brake Icon:** Show icon when braking.
- **Assistant Level:** 3 modes optional (3/5/9)
- **Power:** Real-time Power or Current.
- **Smart battery Power indicator:** Provide a reliable battery Power indicator.
- **Maintenance Icon:** When Odometer reached presetting (Default 5000KM),  will be showed, reminding maintenance. This function is reserved and inactivated by default.
- **Battery Voltage:** Capacity (percentage) or voltage.
- **Riding Time:** Display riding time or speed information.
- **Speed Value/Speed Scale/Speed Pointer:** Real-time SPEED indicator
- **LOGO**

7. Functional Description

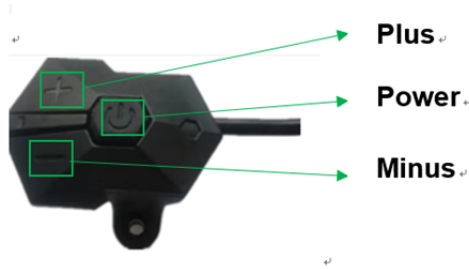

7.1 Power On/Off

Pressing **Power** button for 2.5 seconds, you can turn on/off the display. The Display can automatically turn off when there is no operating & riding for 5 minutes. (Length of time can be set, refer to 8.1.4 'Auto Power off Setting')

*Input pattern in first if pattern unlock was activated.

*Display will be locked for 60 seconds after 3 times failed attempt.

7.2 User interface operating

User interface including 3 pages: Main Page, Chart Page, Menu Page.

Touch screen operation: Swipe down from the upper edge (arrow) of Main Page, you can switch to Menu Page, swipe up from the lower edge of Main Page can switch to Chart Page.

Button operation: Double click **Power** button can switch page (click interval less than 0.3 second), Main Page → Chart Page → Menu Page → Main Page.



Swipe down from the upper edge



Swipe up from the lower edge



Main Page

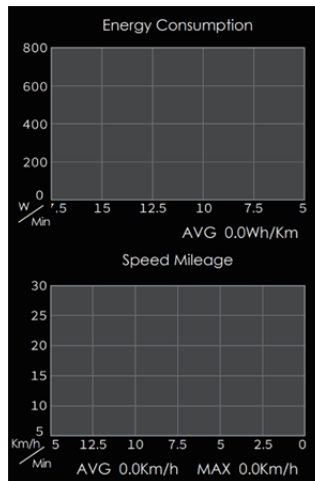
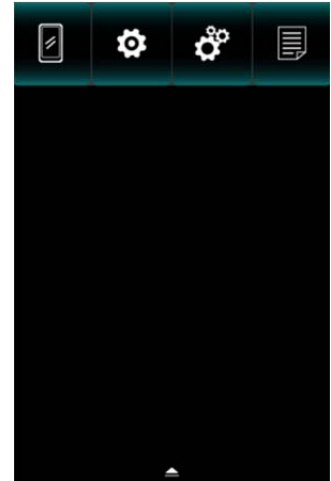

Chart Page



Menu Page

- * Display will return Main Page automatically if there is no operation for 30 seconds.
- * Display will be locked on Main Page when speed is over 2 km/h, function of switching page through touch screen or button will be deactivated.

7.3 Assistant level

Press **Plus/Minus** button to change assistant level, level 0 is no assistance.

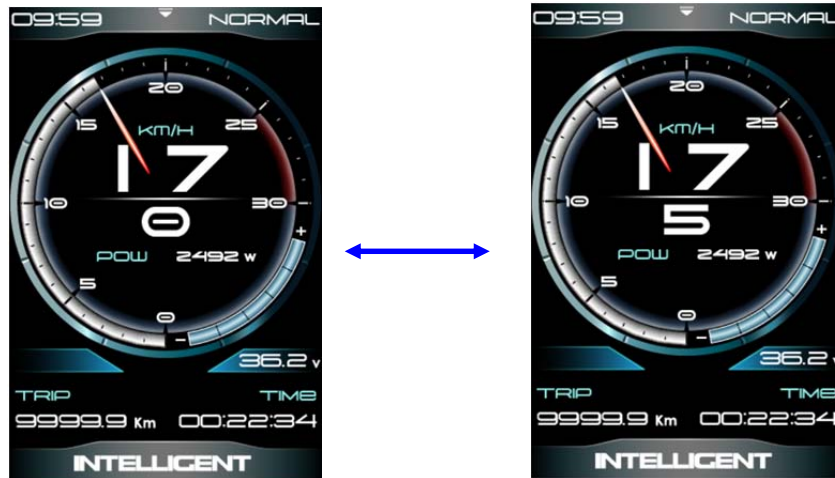

Assistant level

7.4 Speed & Mileage mode

Click **Power** button can change items on Main Page, sequence as below:



TRIP → ODO → RANGE → TRIP

Mileage Mode



TIME → MAX SPEED → AVG SPEED → TIME
Speed Mode

* If there is no operation for 5 seconds, right item will restore to Time automatically.

7.5 Headlight / Display Mode/ Light Sensor

Press and hold **Plus** button for 2 seconds can turn on/off headlight, display will switch to the corresponding mode (Day or Night).

Build in light sensor can turn on/off headlight automatically according to external brightness.



Headlight mode

* Light sensor's sensitivity can be customized. Refer 8.1.3 Bright Setting

* If you operated headlight through button, light sensor will be deactivated until reboot.

7.6 Walking mode (6km)

Press and hold **Minus** button for 2 seconds can get into walking mode, show 'P' on screen, out of walking mode when releasing button.



Walking Mode

7.7 Data cleanup

Press and hold **Plus** & **Minus** button together for 1 second can clean temporary data (TRIP, Riding-Time, AVG SPD, MAX SPD, Kcal, Chart data).

* Temporary data is automatically saved when power off. Abnormal power outage will cause data lost.

* Restore Factory Mode (advanced settings in Menu Page) can clear temporary data (TRIP, Riding-Time, AVG SPD, MAX SPD, Kcal, Chart data, MENU settings) except ODO.

* ODO will reset to zero over 99999km. TRIP will reset to zero over 9999.9km.

7.8 USB charging port

Set USB port on/off. USB provides charging for mobile devices, DC 5V 500mA.

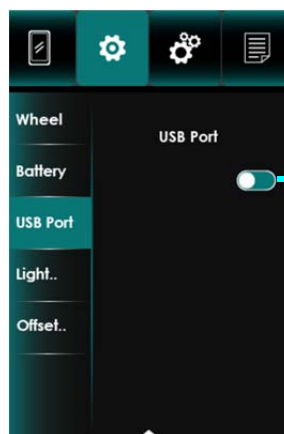

USB port

8. Menu Page

Touch and switch to Menu Page (section 7.2)

* Menu Page will return to Main Page automatically if there is no operation for 30 seconds.

* For safety reason, display will be locked on Main Page when riding (speed over 2 km/h),

function of switching Page through touch screen or button will be deactivated.

* Display didn't save setting until click OK to confirm.

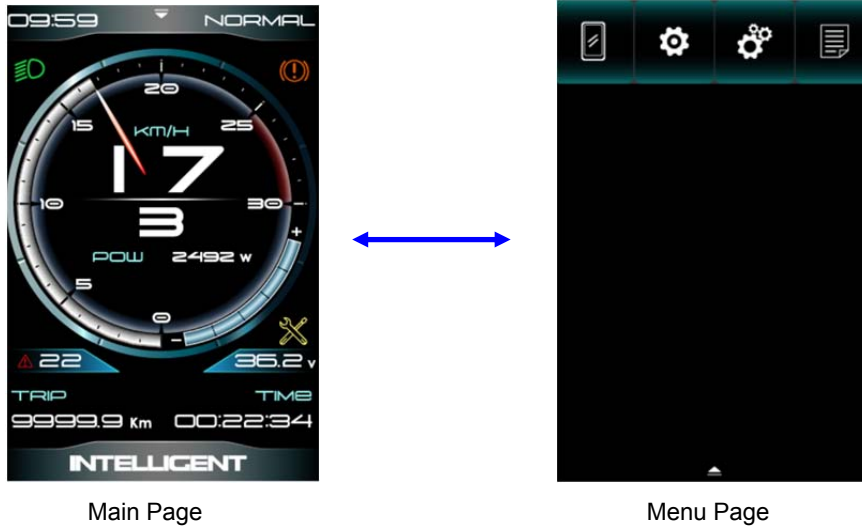

There are 4 columns on Menu page:

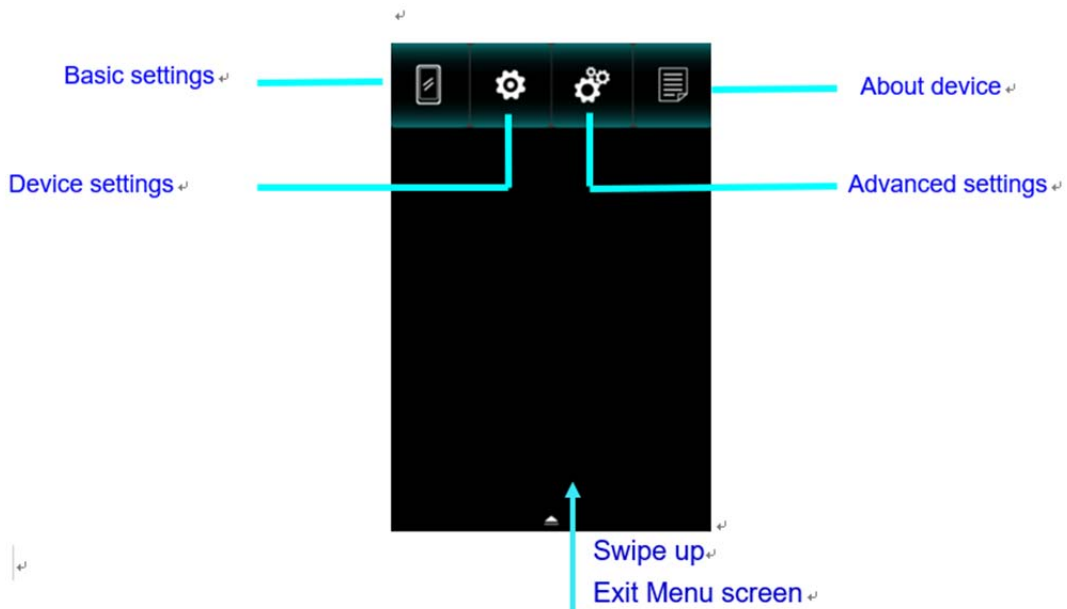

8.1 Basic settings

Basic settings include several items: Language, System, Brightness, Automatic Shut Down, Temperature, Battery Indication, Power Indication, Clock, Security.

8.1.1. Language

8 languages are supported: German, French, Korean, Dutch, Italian, English, Chinese, Czech. Default is English. Select language then click "OK" to confirm.

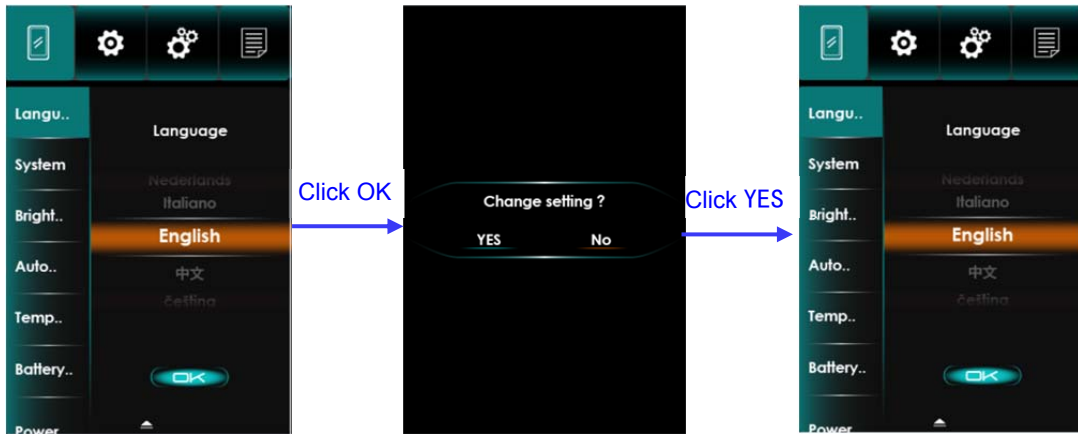

Language

8.1.2. System

Select Metric and Imperial.

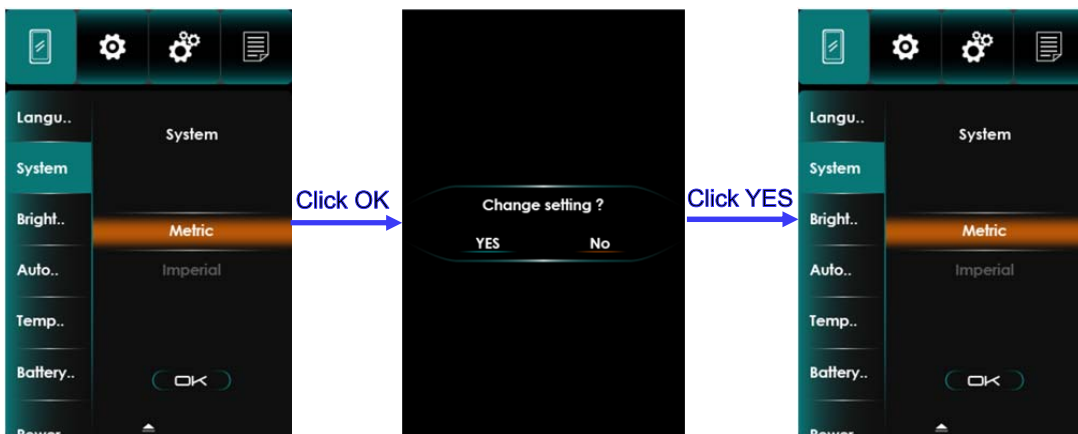

Metric and Imperial

8.1.3. Brightness

Use slide bar to change brightness of backlight, Night Setting is applied on headlight on status.

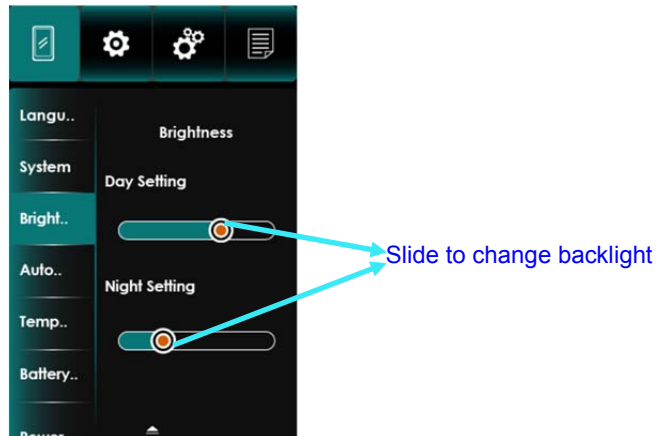

Brightness

8.1.4. Automatic shut down

This item set automatic shutdown duration. 'OFF' represents deactivating Automatic Shut Down. '5 Minutes' represents display shut down when there was no operation and riding for 5 minutes.

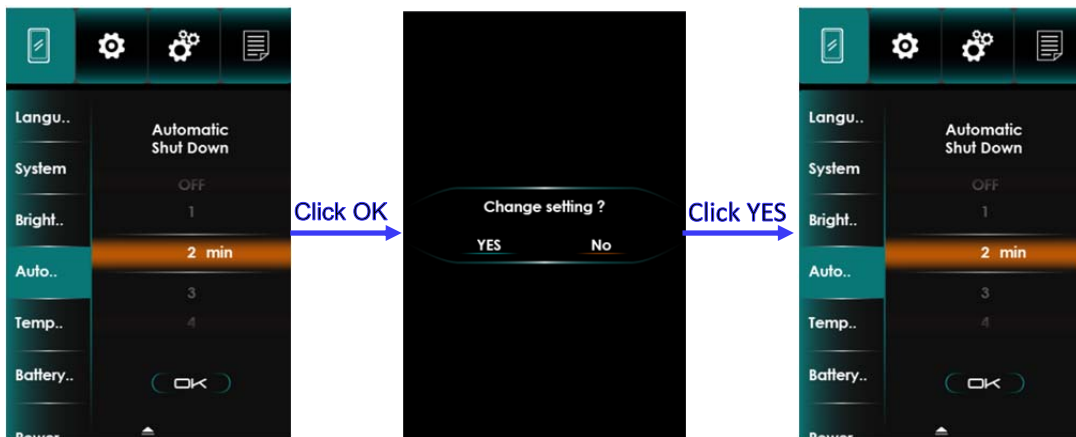

Automatic Shut Down

8.1.5. Temperature

This page can show component's temperature, such as controller, motor or battery. This function needs system support and is deactivated for now.

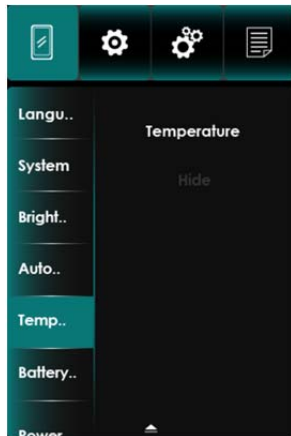

Temperature

8.1.6. Battery Ind

This item set battery's indicator on Main Page, 'Voltage' will show battery's voltage on Main Page, 'Percent' will show battery's remaining capacity in percentage.



Battery Ind



Voltage



Percentage



OFF

8.1.7. Power Ind

This item set power indicator on Main Page, 'OFF', 'Output Power(W)' and 'Current(A)'.

Note: Power indicator represent battery's output power (current), not motor.



Slide up and down
See more items

Power



Output power (W)



output current(A)



Power (OFF)

8.1.8. Clock

This item set date and time. You can choose show or hide Clock on Main Page through switch bar.

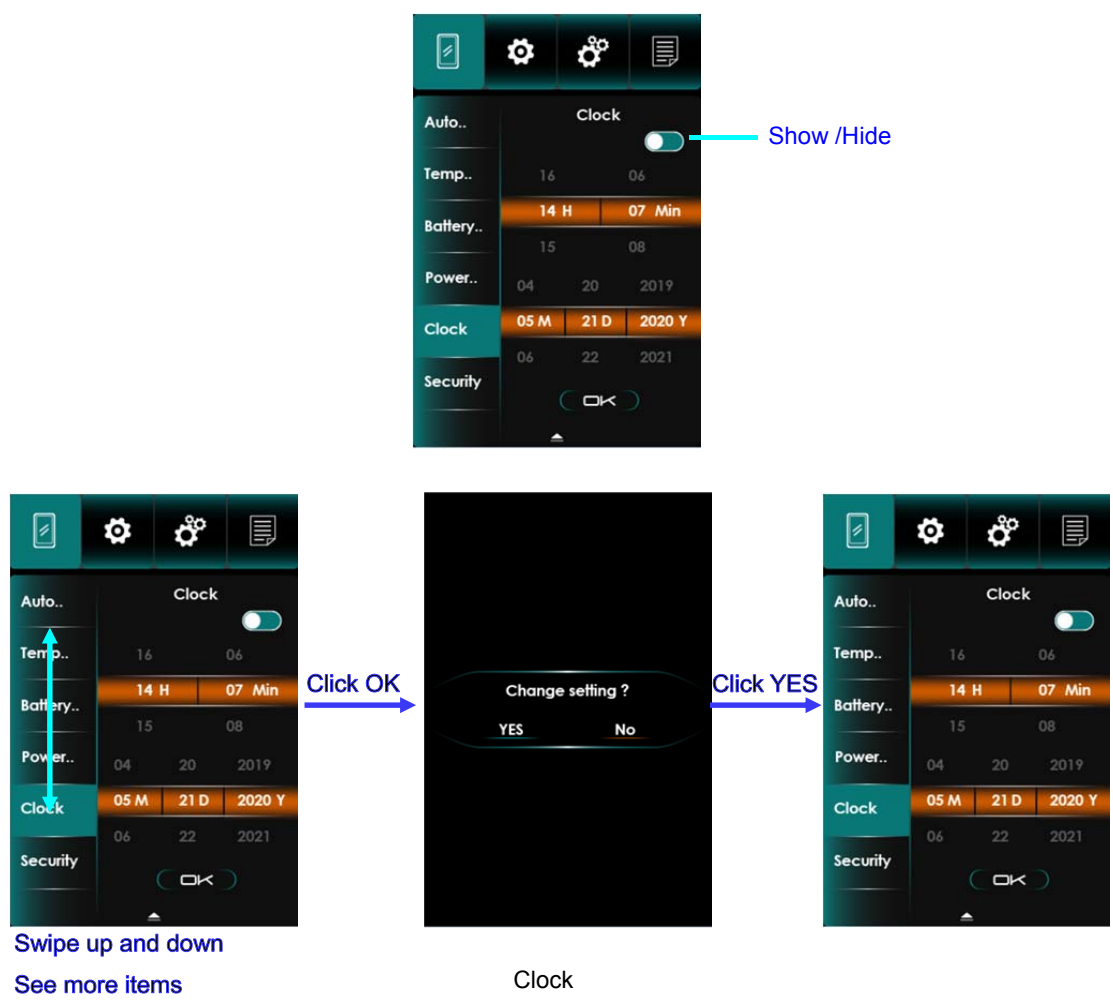

* Note: When display was powered off, internal Button Battery can keep clock running. When display is power on, Button Battery will be charged by external battery. Clock may slow or stop if Button Battery is low, please charge the battery as follows: Set “Automatic shutdown” to “OFF” (Disable power off automatically), keep the display power on for 72 hours. Full charged Button Battery can keep clock running at least 3 months without charged.

8.1.9. Security

This Item is used for system security. You need to input correct pattern if pattern unlock was activated. Pattern unlock can be clear or reset through security questions.

- * If you entered wrong pattern 3 times, display will be locked for 60 seconds before try again.
- * Display will power off after entering wrong security questions 3 times, you have to restart the display.

1. Set Pattern
 - 1) Click OK on Security Page to get into Pattern setting.
 - 2) Draw a special pattern (connect at least 4 points) as the unlock code, draw same pattern again and then click 'OK' to confirm.
2. Set Security Code

- 1) Input 4 digits (recommend using birthday) and then click 'NEXT'.
- 2) Input another 4 digits (recommend using Phone number) and then click 'OK'.
- 3) Click 'OK' on Security Page will finish security setting and Pattern unlock has been activated. Choose 'Close pattern' can deactivated Pattern unlock, choose 'Change pattern' can change a new pattern.

Note: Remember Pattern or two sets of 4-digit passwords carefully, display will be permanent locked if forget them both.

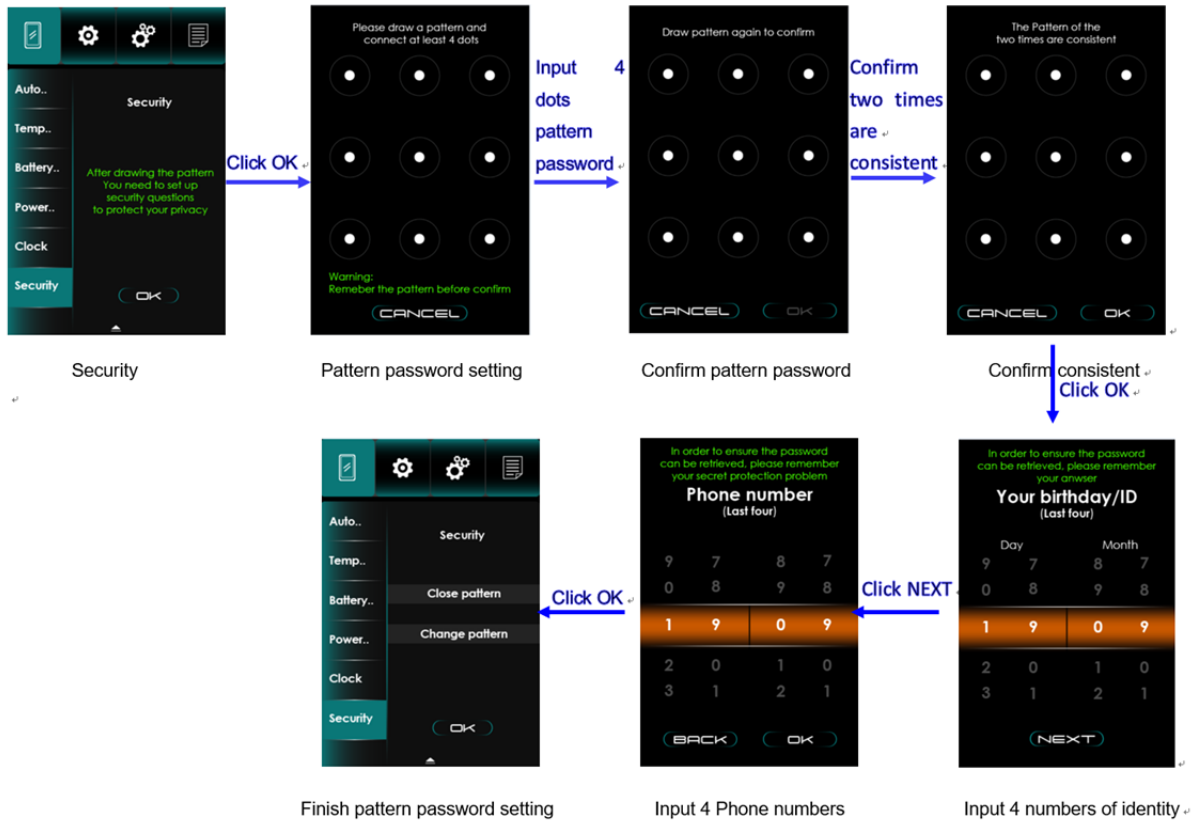

- 4) Pattern needs to be re-draw if you draw 2 different pattern during settings.

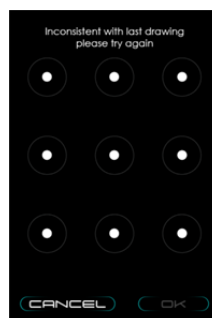

3. Forget pattern

You can reset pattern by input 4-digit code.

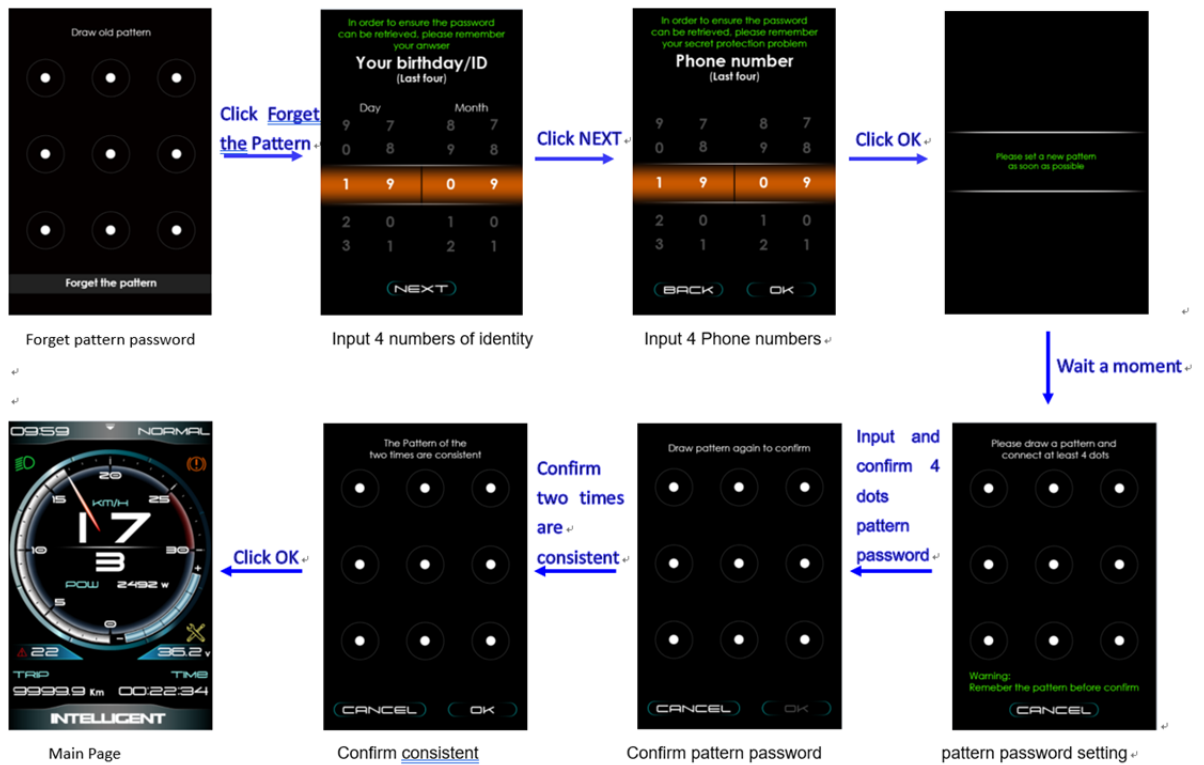

4. Cancel pattern

On 'Security' page, select 'Disable Pattern' can deactivate Pattern unlock.

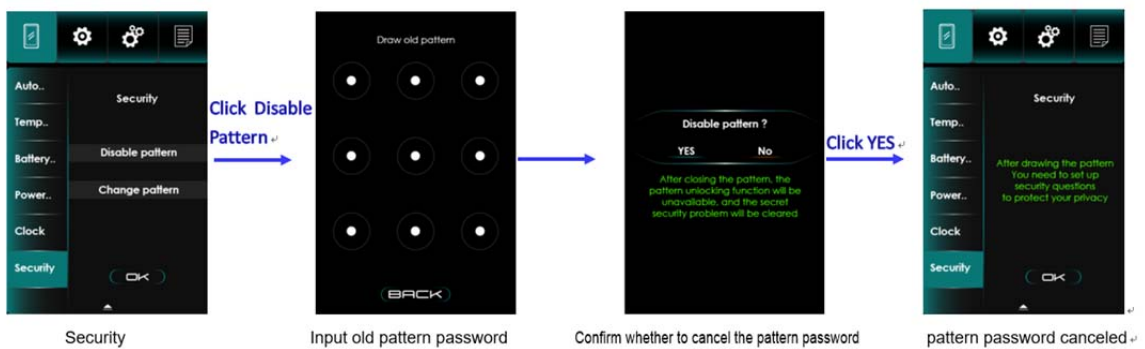

5. Change pattern

On 'Security' page, select 'Change Pattern' and follow the instruction. Changing pattern operation will change security codes simultaneously.

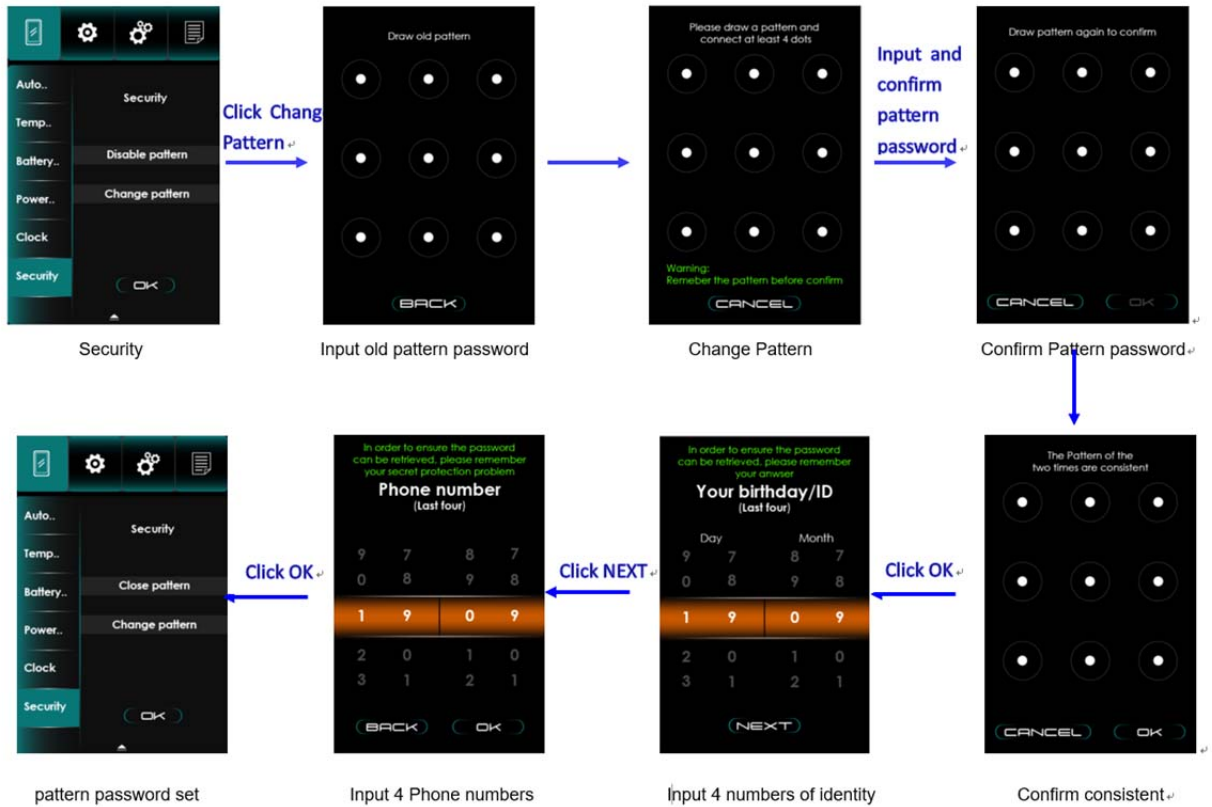

8.2 Device setting

Device setting includes Wheel, Battery, USB Port, Light Sensor, Offset Voltage

8.2.1. Wheel

On 'Wheel' page, select unit 'inch' or 'cm', 'inch' option represent wheel diameter, including 12/14/16/18/20/22/24/26/27/27.5/28/29/30/31. 'cm' option represent wheel circumference, range from 51cm-254cm.

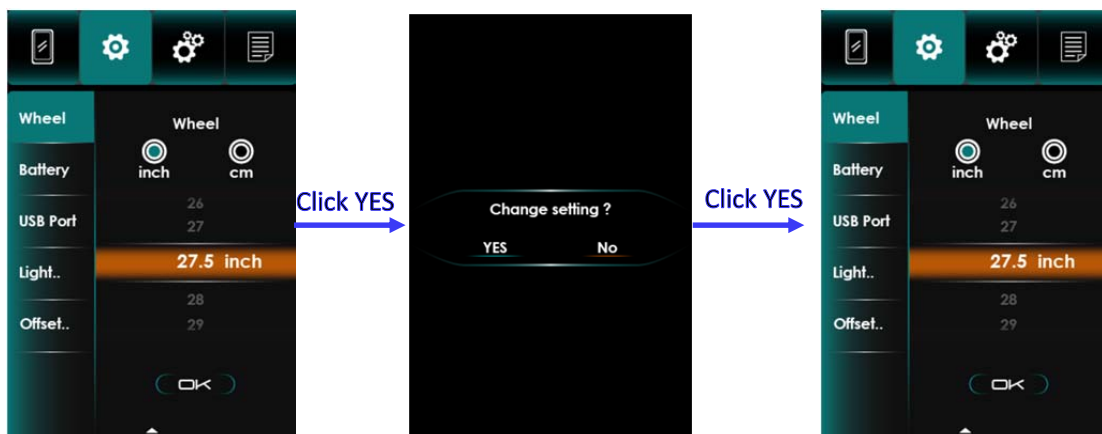

Wheel

8.2.2. Battery Voltage

This item is unused in Bafang system.



Battery Voltage

8.2.3. USB Port

You can set ON/OFF of USB port through switch bar.

USB port: Type-C,5V/500mA

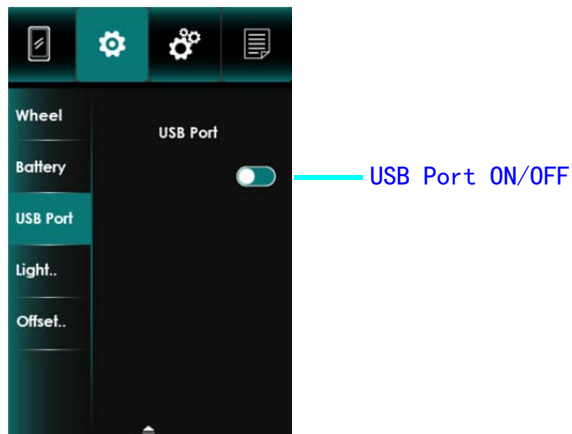

USB Port

8.2.4. Light sensor

Set Light sensor on this page.

LOW: Light sensor acts more darkness.

High: Light sensor acts more brightness.

OFF: Light sensor is deactivated.

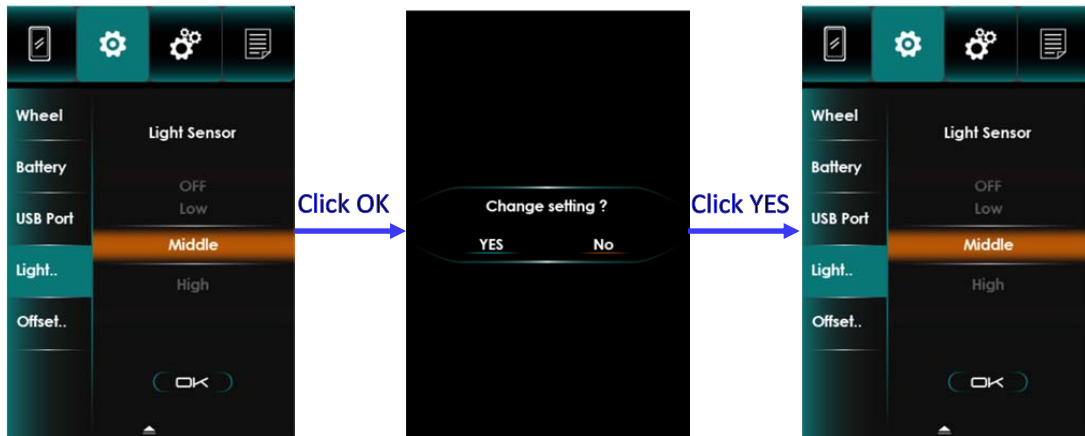

Light sensor

8.2.5. Offset Voltage

Offset Voltage is used to compensate voltage sampling deviation caused by hardware, range from -1.0V to 1.0V. Voltage value on Main Page will be more accurate($\pm 0.1V$).

Measure battery's voltage and compare with the voltage on Main Page, make them equal through adjusting Offset voltage.

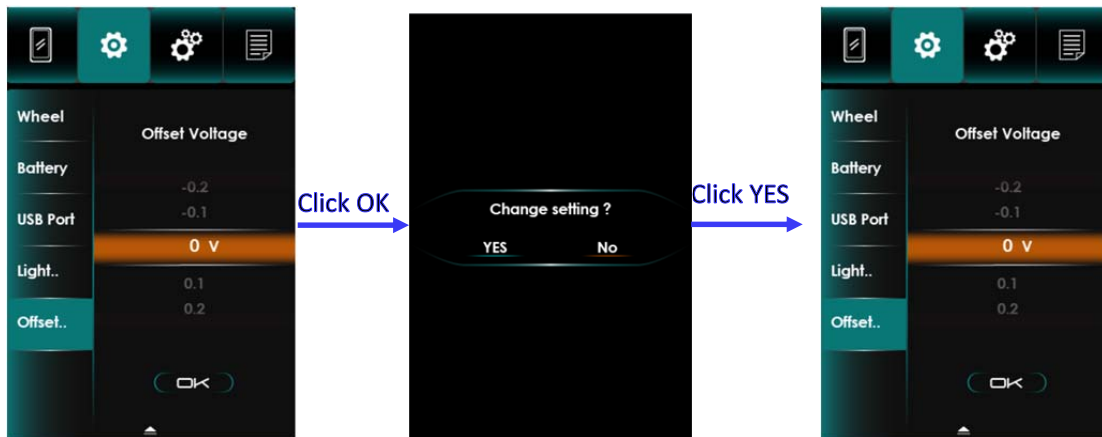

Offset voltage

8.3 Advanced setting

Advanced settings have password to prevent illegal modification, default password is '100001', password may be different according to request .

Advanced setting includes: Speed Limit、Calorie、Maintenance、Gear Number Setting、Riding Mode、Factory setting.

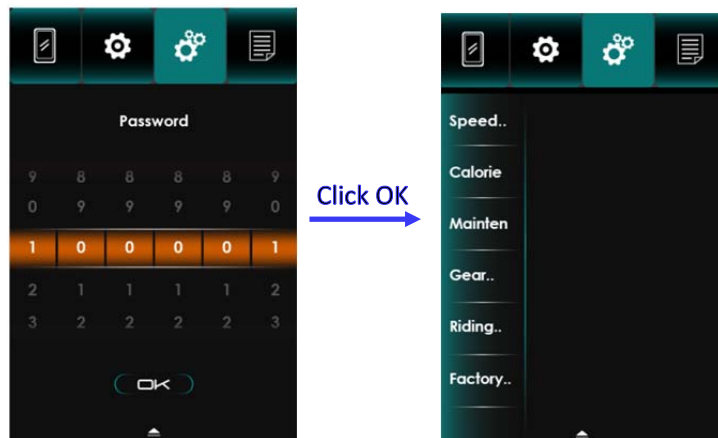

Input password to enter advanced setting page

8.3.1. Speed Limit

Speed limit range: 10km/h-100km/h.

Note: Maximum speed is restricted by controller and motor.

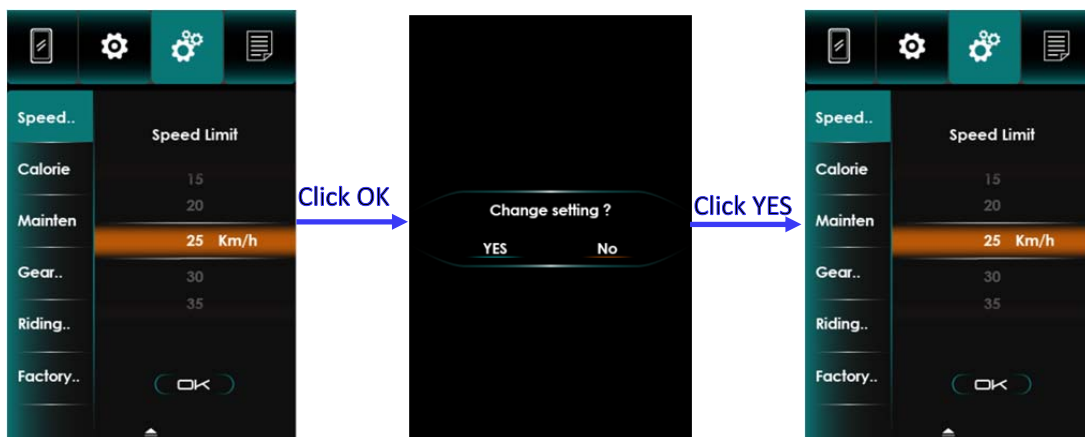

Speed Limit

8.3.2. Calorie

This item shows Calorie consumption. This function is reserved and invalid for now.



Calorie

8.3.3. Maintenance

This function is reserved and invalid for now.



Maintenance

8.3.4. Gear number setting

This item can customize number of assistant level.

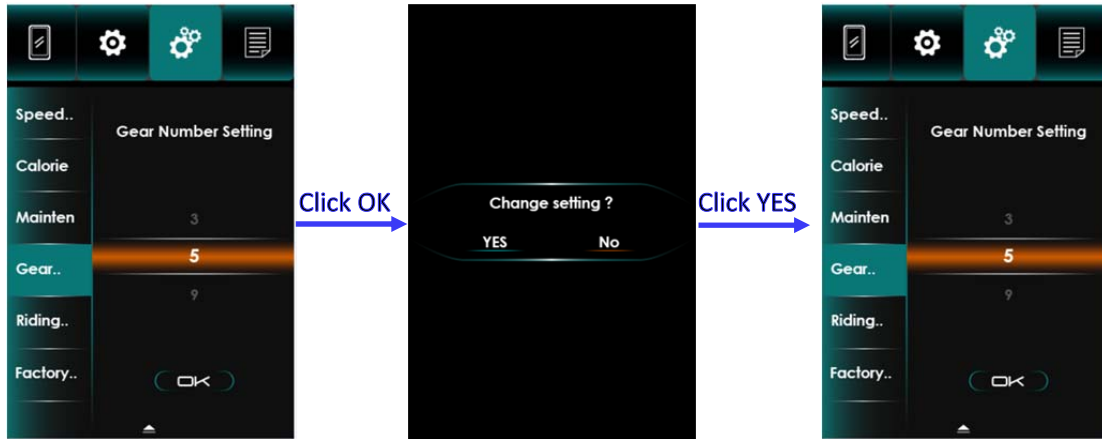

Gear Number

8.3.5. Riding mode

This item can change the riding mode (need system support).

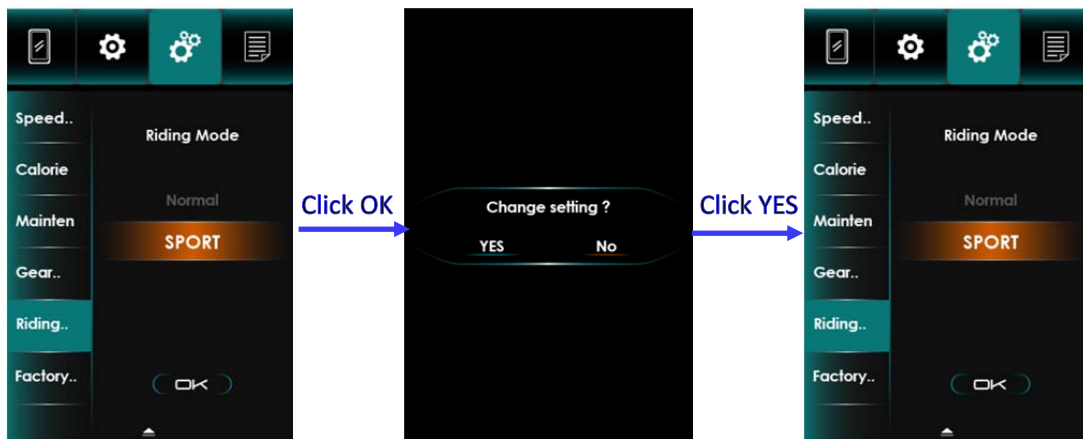

Riding mode



SPORT



NORMAL

8.3.6. Factory Setting

Click 'OK' will restore all setting to factory defaults, it also clear temporary data.

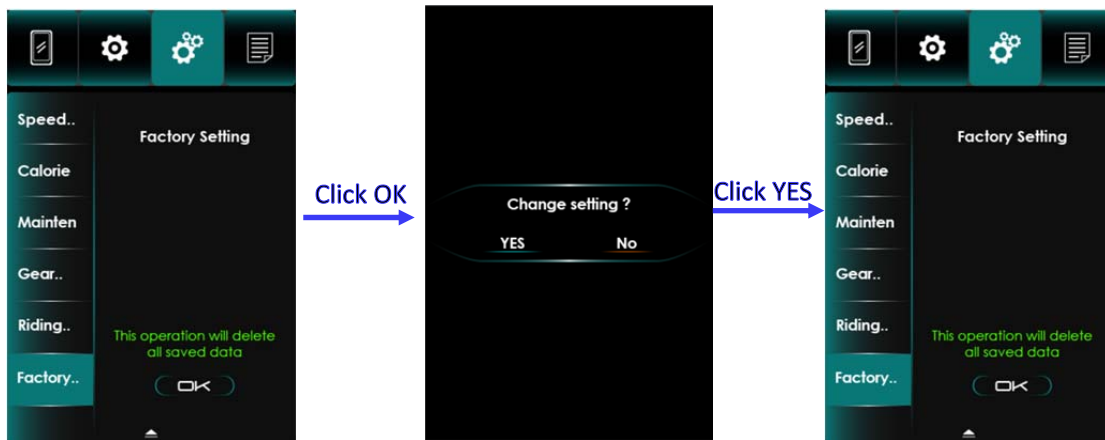

Factory

8.4 About Device

Show information of device

8.4.1 Product Information

Product Information show Software Version、Date、Serial No.

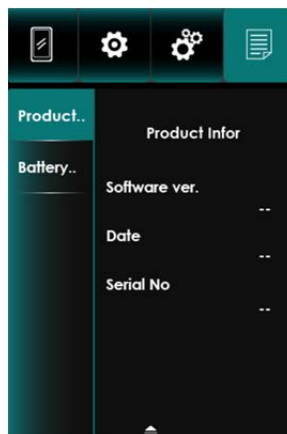

Product information

8.4.2 Battery Information

Battery Information can show voltage、Current、Capacity、Health、Cycle times、Remaining Capacity、Full Charge Capacity、Temperature、Max Un-charge Times、Last Un-charge Times.

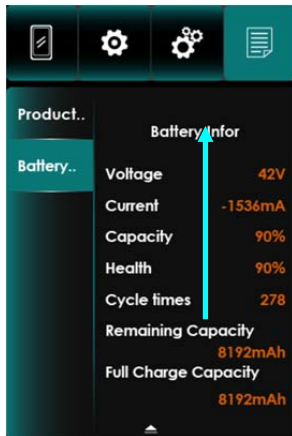

Swipe Up
and down

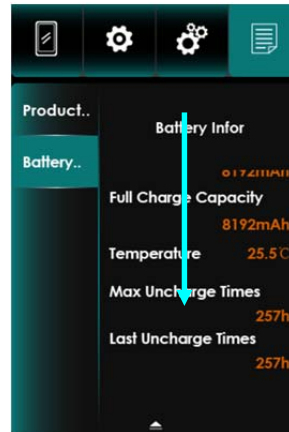

Battery Information

9. Chart Page

There are energy consumption and speed mileage graph on Chart Page, you can review last 60 minutes max.

Swipe the graph horizontally to see more information.



Swipe up
Enter the chart page

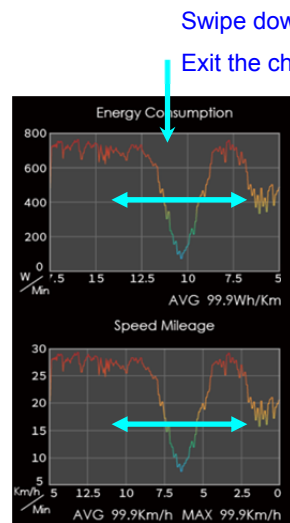

Swipe down
Exit the chart page

Swipe horizontally can
see more information

Chart page

10.Errors code

Display shows error code when system checked abnormal, you can get instruction by touch error code area .

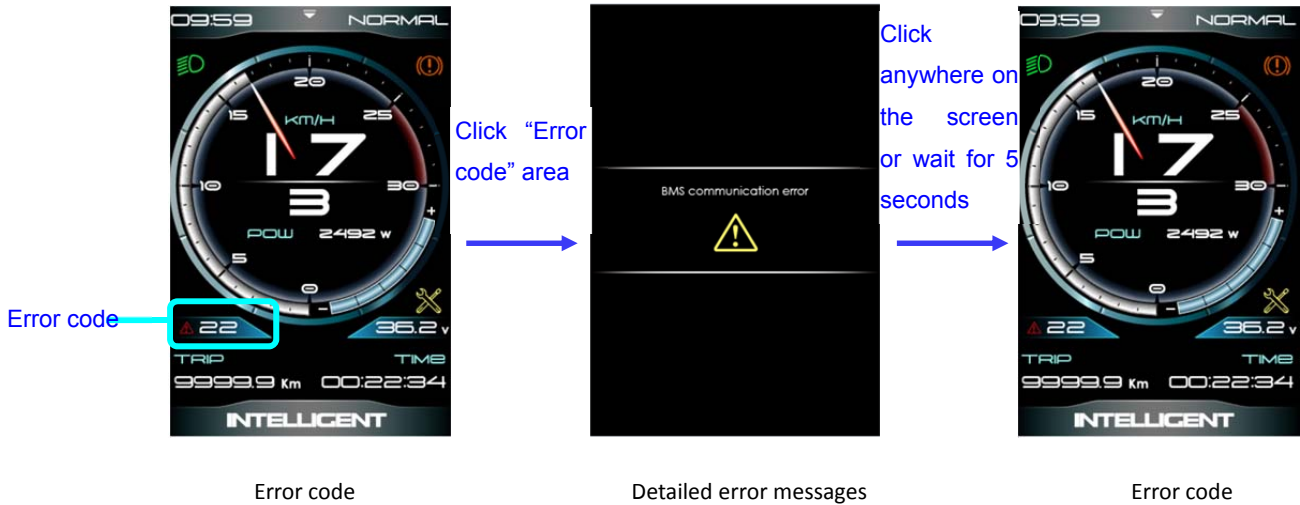

Error code	Instruction	Data
04	Throttle on high position	0x04
05	Throttle error	0x05
07	High voltage protection	0x07
08	Motor's hall sensor error	0x08
09	Phase line of motor error	0x09
10	Controller over temperature	0x10
11	Motor over temperature	0x11
12	Current sensor error	0x12
13	Battery's temperature sensor error	0x13
14	Motor's temperature sensor error	0x14
15	controller's temperature sensor error	0x15
21	Speed sensor error	0x21
22	BMS communication error	0x22
23	Head light error	0x23
24	Head light sensor error	0x24
25	Torque sensor error-Torque	0X25
26	Torque sensor error-speed	0X26
27	overcurrent	0X27
30	Communication error	0X30
31	Please contact the controller manufacturer for repairing	0X31
33	Brake detection circuit error	0X33
35	15V power supply detection error	0X35
36	Button detection circuit error	0X36
37	Watchdog error	0X37

11. Assembly instructions

Please pay attention to the torque value, exceeding the maximum torque can damage the part.

Electrical or pneumatic tools is not recommended.

11.1 Regular bracket

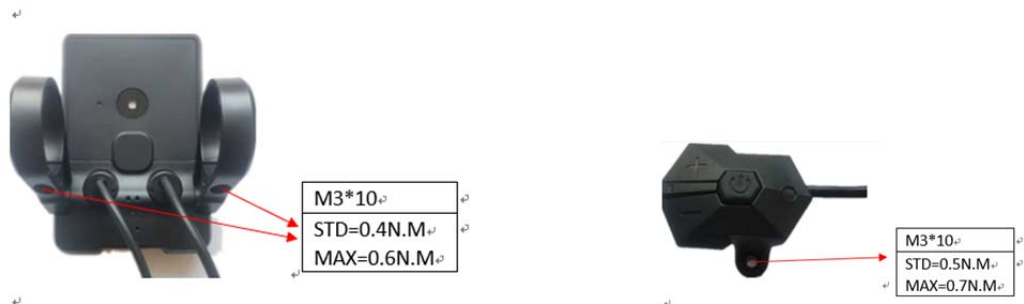

11.2 Headlight bracket

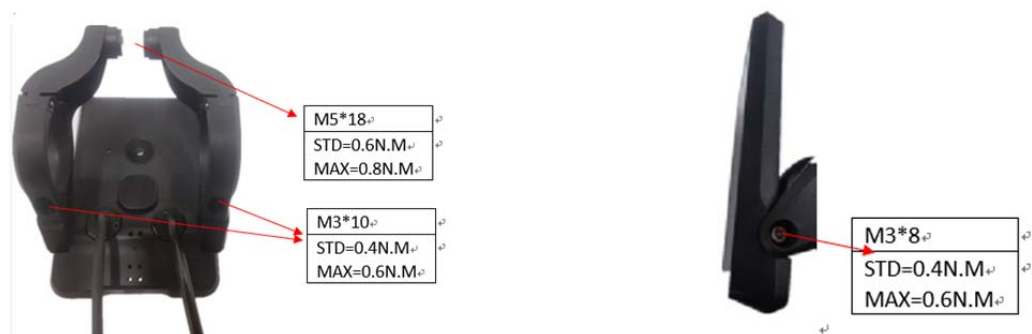

There are 3 pairs of rubber ring to match different handlebars, choose matched rings for assembly.



12. Install and use precautions

Do not adjust viewing angle before loose the screws.

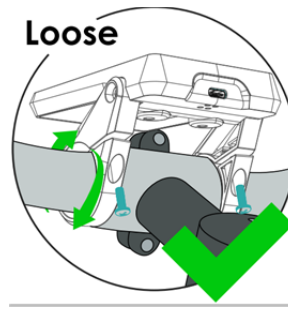
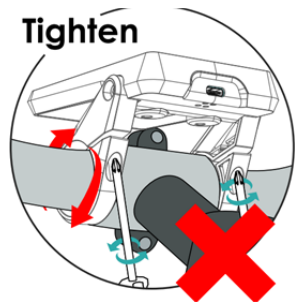

13. Copyright Notice

Questions about your e-bike, please contact with dealer firstly.